



深圳市科源信科技有限公司
Shenzhen KeYuanXin Technology CO., LTD

产品规格书

SPECIFICATION FOR APPROVAL

深圳市福田区振华路 118 号华丽装饰一栋西座 306A
306A Block West Building 1, Huali Decoration
NO.118 Zhenhua Road Futian District Shenzhen
电话 TEL: 4008-735-535 传真 FAX: 0755-23616323



Product Name:

Crystal

Product Type:

SMD 2520

Nominal Freq:

24.0000MHz

ProvideBrand:

KKST

P/N:

KAD24000H01R

Customer P/N:

Approved By Customer

Signature:

Date:



CONTENT

NO.1 Product specification and features

NO.2 Product outline dimension

NO.3 Product reliability

NO.4 Package specification



N0.1 Product specification and features

1.1 General characteristics	
Nominal frequency	24.000000 MHz
Overtone order	Fundamental
Type	SMD2520
Operating temperature	-20~70 °C
Storage temperature	-40~85 °C
1.2 Electric characteristics	
Adjustment tolerance: (at+25°C)	±10 ppm
Tolerance over the temperature:	±20 ppm
Load capacitance	20.0 pF
Drive level	10.0 μW
Equivalent resistance	40.0 Ω Max
Shut capacitance	7.0pF Max
Insulation resistance	500 M Ω Min 100VDC ± 15VDC
Aging	±3ppm/Year
1.3 Other characteristics	
SPDB	<-3 dB

NO.2 Outline dimensions、Appearances

2.1 Product outline dimension(mm)

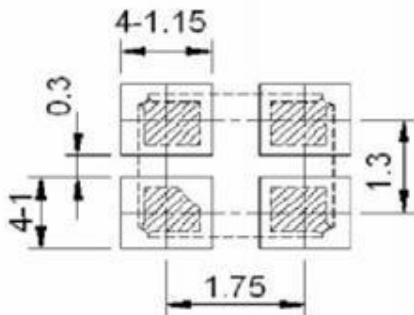
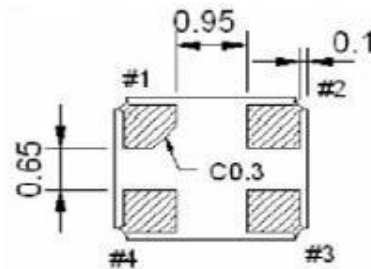
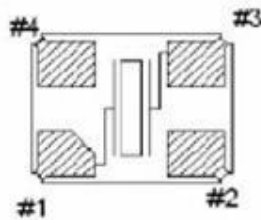
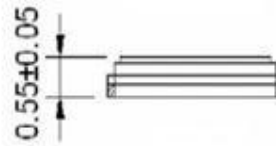
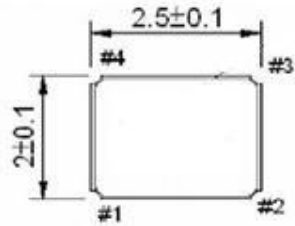

2.2 Carrier Dimensional Drawing (mm)

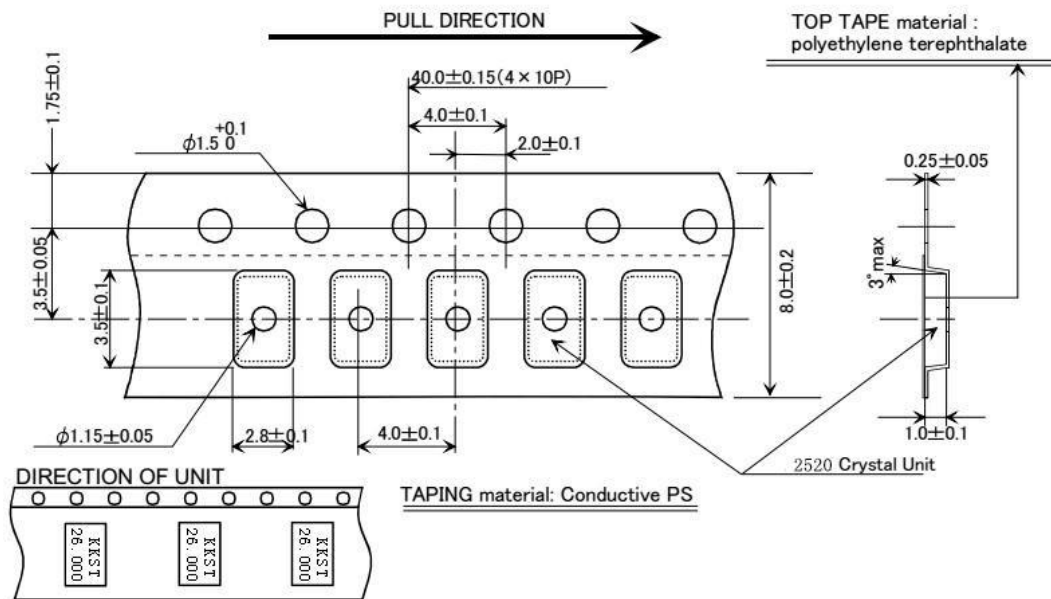

2.3 Reel Dimensional Drawing (mm)

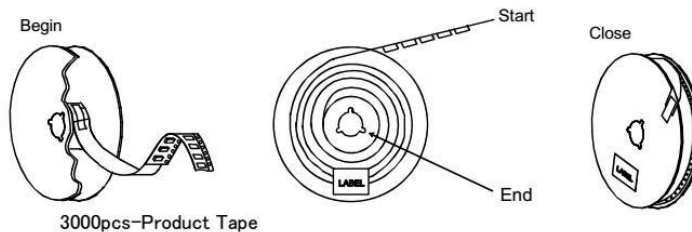
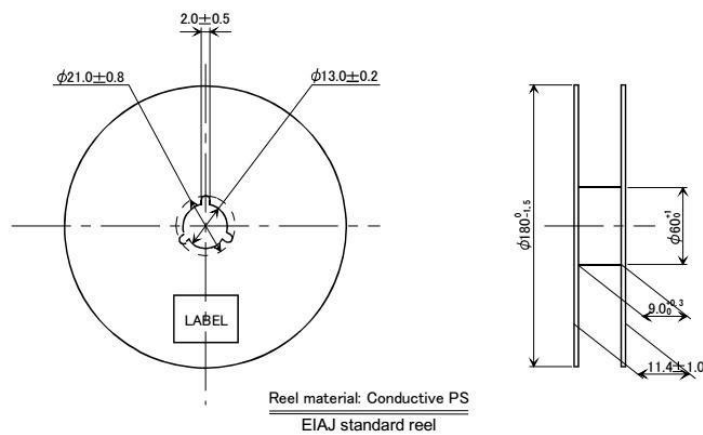

NO.3 Product reliability

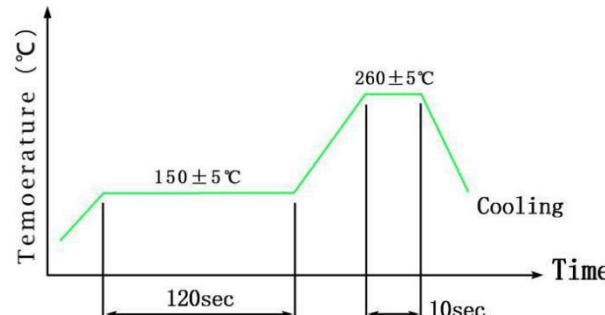
Item	Condition	Result
A1	Cold resistance Stored at $-40\pm 2^{\circ}\text{C}$ for 1000 ± 2 hrs then $25\pm 2^{\circ}\text{C}$ 1~2 hrs before testing	(I)
A2	Heat resistance Stored at $85\pm 2^{\circ}\text{C}$ for 1000 ± 2 hrs then $25\pm 2^{\circ}\text{C}$ 1~2 hrs before testing	(I)
A3	Salt Mist Test Spray the $35^{\circ}\text{C}\pm 2^{\circ}\text{C}$ salt water (salt density 5%) to crystal for 48 ± 2 hrs,then clean by water	(I)
A4	Humidity Resistance Result Steady temperature: $60\pm 2^{\circ}\text{C}$;humidity: 90 ~ 95 % RH; time:500h	(I)
A5	Mechanical Shock 14700m/S^2 0.5sec 5times in each of 6 direction	(I)
A6	Aging Stored at $85\pm 3^{\circ}\text{C}$ for 720 ± 12 Hrs then $25\pm 2^{\circ}\text{C}$ 1~2 Hrs before testing Stored at $25\pm 2^{\circ}\text{C}$ for 1 ± 0.03 year	(I)
A7	Leakage Fine leak: Helium leak test *JIS C 6701 10.6	(V)
A8	<p>Temperature Cycle $-40^{\circ}\text{C} \sim 85^{\circ}\text{C}$, Dewell 30Min, 100 cycles</p>  <p>The graph shows a temperature cycle with two dwell periods. The first dwell is at $150\pm 5^{\circ}\text{C}$ for 120 seconds. The second dwell is at $260\pm 5^{\circ}\text{C}$ for 10 seconds. The cooling phase is labeled 'Cooling'.</p>	(I)

3.1 Mechanism characteristics

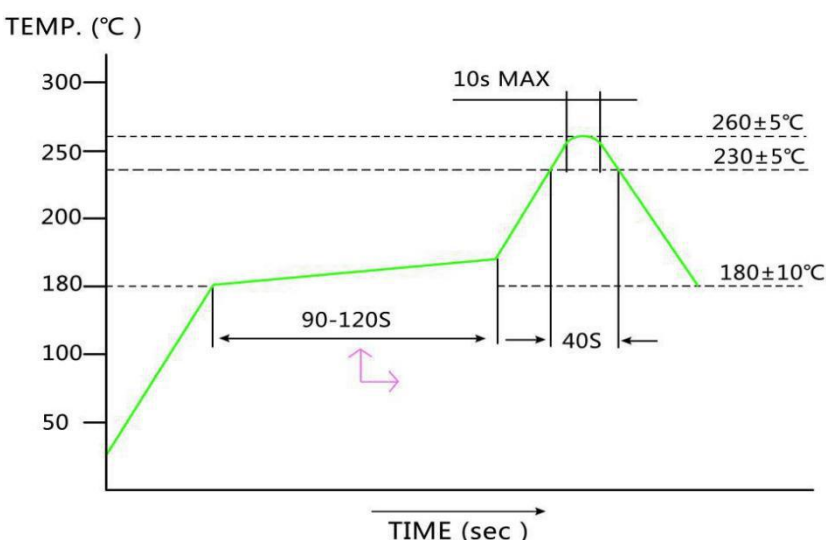
<p>B.1</p>	<p>Drop Test Device are dropped from a height of 100 cm onto 20mm thickness stainless plate executing 3 times of random drops</p>	<p>(I)</p>
<p>B.2</p>	<p>Resistance of Vibration Frequency: 10~55Hz, amplitude(total excursion): 1.5mm±15%,3 direction (X,Y,Z) each 2 hr</p>	<p>(I)</p>
<p>B.3</p>	<p>Resistance to soldering heat (Hand soldering method) Temperature: 370~400°C; Time: 3~4sec; Frequency: 2 times; Soldering iron: 60W/Min</p>	<p>(I)</p>
<p>B.4</p>	<p>Solderability 240±2°C, 3±0.5sec</p>	<p>(II)</p>
<p>B.5</p>	<p>Reflow) Resistance to soldering heat (Reflow) 260±5°C; 10S; 2Times</p> <p style="text-align: center;">Reflow</p>  <p>TEMP. (°C)</p> <p>300 250 200 180 100 50</p> <p>90-120S</p> <p>10s MAX</p> <p>260±5°C</p> <p>230±5°C</p> <p>180±10°C</p> <p>40S</p> <p>TIME (sec)</p>	<p>(I)</p>



Item	Result NO.	Specification Requirements
1	(I)	Frequency variation $< \pm 10 \text{ppm}$ Resistance variation $< 5 \Omega$ or 15% of RR spec., select the bigger value
2	(II)	The covering rate of Tin-plating is more than 95%
3	(III)	There is no bubbles after the Crystal is dipped in the water Insulation Resistance: $500 \text{ M}\Omega$ Min $100\text{VDC}/\pm 15\text{VDC}$
4	(IV)	The Crystal is no crackle under the observation of 10 times Magnifier.
5	(V)	$1 \times 10^{-9} \text{Pa}\cdot\text{m}^3/\text{s}$ Max

NO.4 Package specification

4.1 Marking



4.2 Label

KKST KEYUANXIN TECHNOLOGY GO.,LTD		
Item	Crystal	QTY: 3000PCS
P/N	KAD24000H01R	
FREQUENCY	24.000MHz	DATE: 2018-03-12

4.3 Package specification

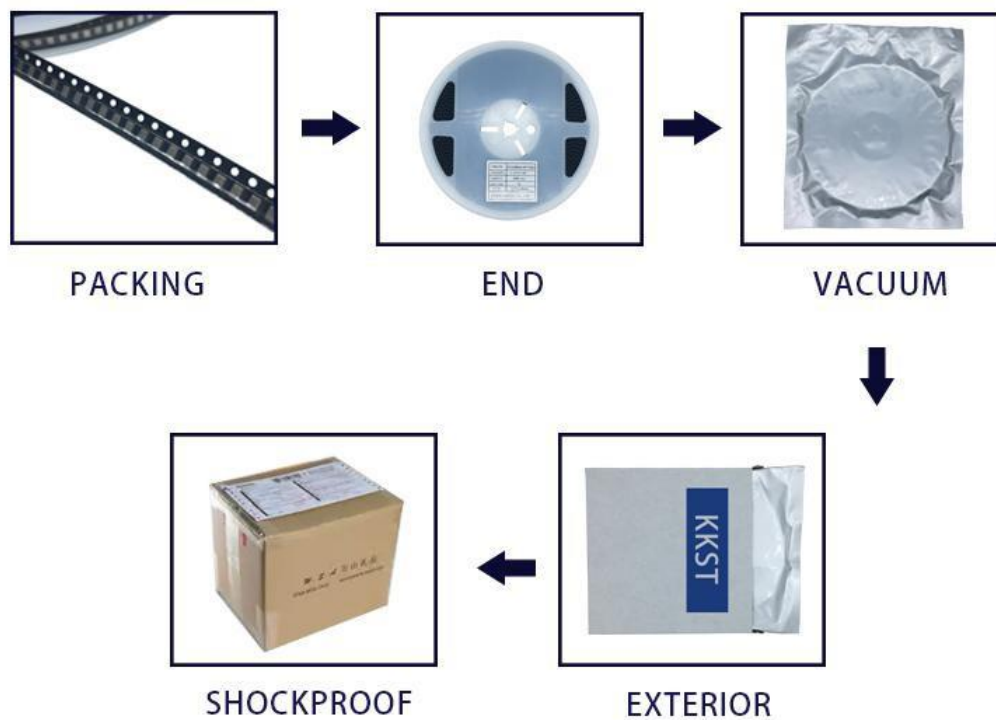



KEYUANXIN TECHNOLOGY GO.,LTD

浏览网址：www.szkyx.cn