



深圳市科源信科技有限公司  
Shenzhen KeYuanXin Technology CO., LTD

# 产品规格书

**SPECIFICATION FOR APPROVAL**

深圳市福田区振华路 118 号华丽装饰一栋西座 306A  
306A Block West Building 1, Huali Decoration  
NO.118 Zhenhua Road Futian District Shenzhen  
电话 TEL: 4008-735-535 传真 FAX: 0755-23616323



Product Name:

Crystal

---

Product Type:

SMD 2520

---

Nominal Freq:

27.0000MHz

---

ProvideBrand:

KKST

---

P/N:

KAD27000C01R

---

Customer P/N:

---

**Approved By Customer**

**Signature:**

**Date:**

---



## **CONTENT**

- NO.1 Product specification and features**
  
- NO.2 Product outline dimension**
  
- NO.3 Product reliability**
  
- NO.4 Package specification**



## N0.1 Product specification and features

|                                     |                               |
|-------------------------------------|-------------------------------|
| <b>1.1 General characteristics</b>  |                               |
| Nominal frequency                   | 27.000000 MHz                 |
| Overtone order                      | Fundamental                   |
| Type                                | SMD2520                       |
| Operating temperature               | -20~70 °C                     |
| Storage temperature                 | -40~85 °C                     |
| <b>1.2 Electric characteristics</b> |                               |
| Adjustment tolerance: (at+25°C)     | ±10 ppm                       |
| Tolerance over the temperature:     | ±20 ppm                       |
| Load capacitance                    | 12.0 pF                       |
| Drive level                         | 10.0 μW                       |
| Equivalent resistance               | 40.0 Ω Max                    |
| Shut capacitance                    | 7.0pF Max                     |
| Insulation resistance               | 500 M Ω Min 100VDC ±<br>15VDC |
| Aging                               | ±3ppm/Year                    |
| <b>1.3 Other characteristics</b>    |                               |
| SPDB                                | <-3 dB                        |

## NO.2 Outline dimensions、Appearances

### 2.1 Product outline dimension(mm)

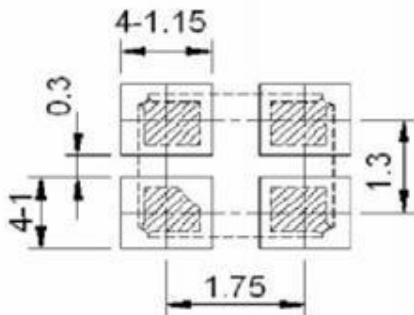
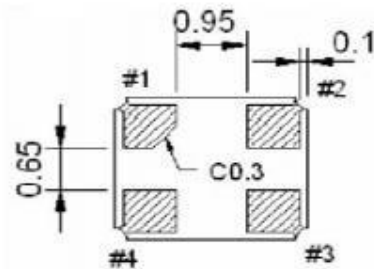
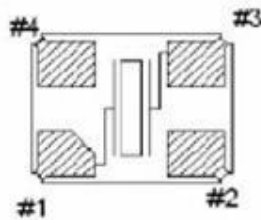
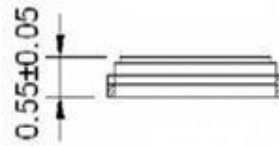
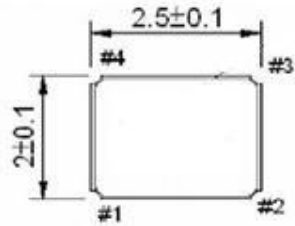



### 2.2 Carrier Dimensional Drawing (mm)

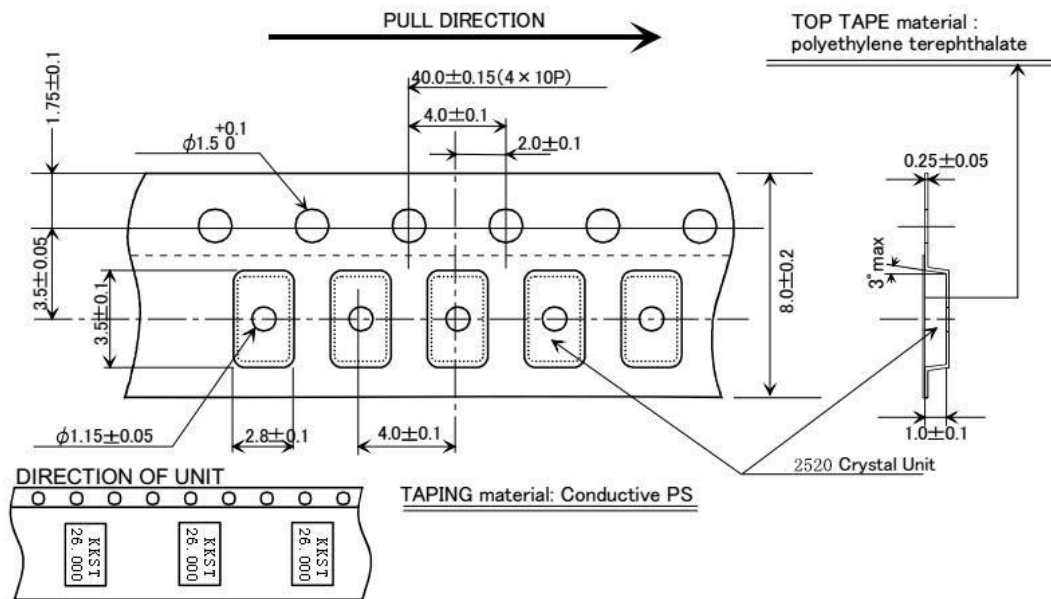

### 2.3 Reel Dimensional Drawing (mm)

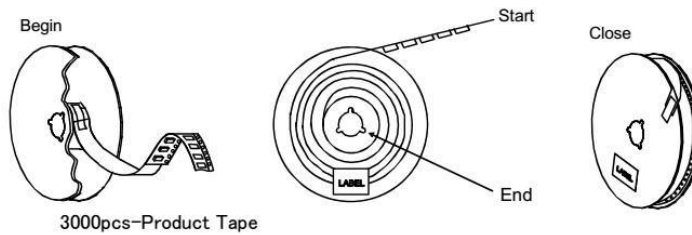
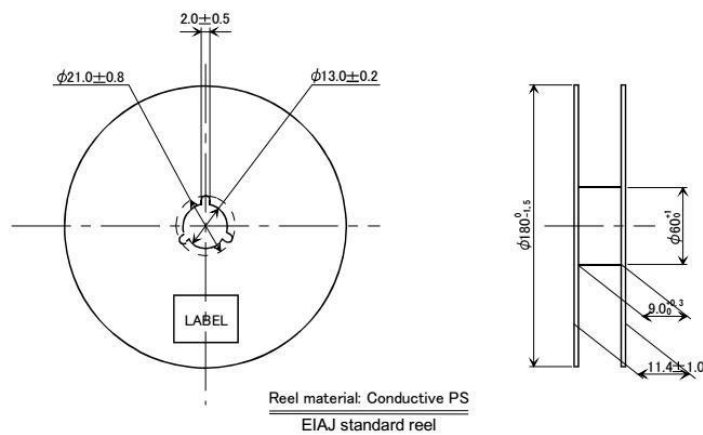

### NO.3 Product reliability

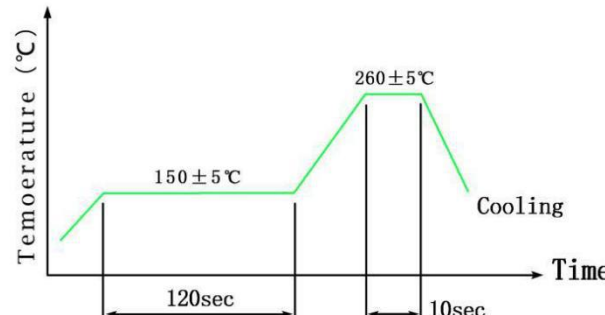
| Item | Condition   | Result |
|------|---|--------|
| A1   | <b>Cold resistance</b><br>Stored at $-40\pm 2^{\circ}\text{C}$ for $1000\pm 2$ hrs then $25\pm 2^{\circ}\text{C}$ 1~2 hrs before testing  | (I)    |
| A2   | <b>Heat resistance</b><br>Stored at $85\pm 2^{\circ}\text{C}$ for $1000\pm 2$ hrs then $25\pm 2^{\circ}\text{C}$ 1~2 hrs before testing   | (I)    |
| A3   | <b>Salt Mist Test</b><br>Spray the $35^{\circ}\text{C}\pm 2^{\circ}\text{C}$ salt water (salt density 5%) to crystal for $48\pm 2$ hrs,then clean by water  | (I)    |
| A4   | <b>Humidity Resistance Result</b><br>Steady temperature: $60\pm 2^{\circ}\text{C}$ ;humidity: 90 ~ 95 % RH; time:500h   | (I)    |
| A5   | <b>Mechanical Shock</b><br>$14700\text{m/S}^2$ 0.5sec 5times in each of 6 direction   | (I)    |
| A6   | <b>Aging</b><br>Stored at $85\pm 3^{\circ}\text{C}$ for $720\pm 12$ Hrs then $25\pm 2^{\circ}\text{C}$ 1~2 Hrs before testing Stored at $25\pm 2^{\circ}\text{C}$ for $1\pm 0.03$ year  | (I)    |
| A7   | <b>Leakage</b><br>Fine leak: Helium leak test *JIS C 6701 10.6  | (V)    |
| A8   | <p><b>Temperature Cycle</b><br/><math>-40^{\circ}\text{C} \sim 85^{\circ}\text{C}</math>, Dewell 30Min, 100 cycles</p>  <p>The graph plots Temperature (°C) on the y-axis against Time on the x-axis. The cycle starts with a ramp up to a dwell at <math>150\pm 5^{\circ}\text{C}</math> for 120 seconds. This is followed by a second ramp up to a dwell at <math>260\pm 5^{\circ}\text{C}</math> for 10 seconds. The cycle concludes with a cooling phase labeled 'Cooling'.</p> | (I)    |

3.1 Mechanism characteristics

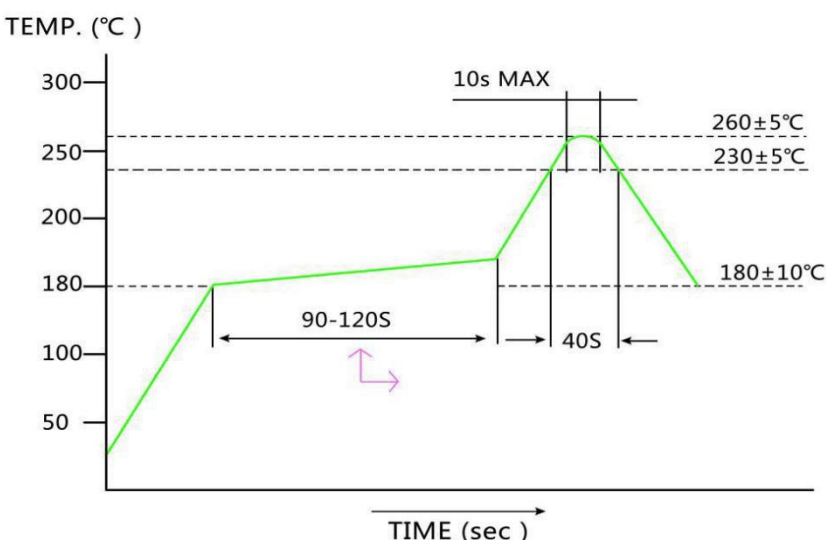
|                   |   |             |
|-------------------|---|-------------|
| <p><b>B.1</b></p> | <p><b>Drop Test</b><br/>Device are dropped from a height of 100 cm onto 20mm thickness stainless plate executing 3 times of random drops</p>  | <p>(I)</p>  |
| <p><b>B.2</b></p> | <p><b>Resistance of Vibration</b><br/>Frequency: 10~55Hz, amplitude(total excursion): 1.5mm±15%,3 direction (X,Y,Z) each 2 hr</p>   | <p>(I)</p>  |
| <p><b>B.3</b></p> | <p><b>Resistance to soldering heat (Hand soldering method)</b><br/>Temperature: 370~400°C; Time: 3~4sec;<br/>Frequency: 2 times; Soldering iron: 60W/Min</p>  | <p>(I)</p>  |
| <p><b>B.4</b></p> | <p><b>Solderability</b><br/>240±2°C, 3±0.5sec</p>   | <p>(II)</p> |
| <p><b>B.5</b></p> | <p><b>Reflow) Resistance to soldering heat (Reflow)</b><br/>260±5°C; 10S; 2Times</p> <p style="text-align: center;">Reflow</p>  <p>TEMP. (°C )</p> <p>300</p> <p>250</p> <p>200</p> <p>180</p> <p>100</p> <p>50</p> <p>10s MAX</p> <p>260±5°C</p> <p>230±5°C</p> <p>180±10°C</p> <p>90-120S</p> <p>40S</p> <p>TIME (sec )</p> | <p>(I)</p>  |





| Item | Result NO. | Specification Requirements   |
|------|------------|--|
| 1    | ( I )      | Frequency variation $< \pm 10 \text{ppm}$<br>Resistance variation $< 5 \Omega$ or 15% of RR spec.,<br>select the bigger value    |
| 2    | ( II )     | The covering rate of Tin-plating is more than 95%  |
| 3    | ( III )    | There is no bubbles after the Crystal is dipped in the<br>water Insulation Resistance: 500 $M\Omega$ Min<br>100VDC/ $\pm 15$ VDC |
| 4    | ( IV )     | The Crystal is no crackle under the observation of 10<br>times Magnifier.  |
| 5    | ( V )      | $1 \cdot 10^{-9} \text{Pa} \cdot \text{m}^3/\text{s}$ Max  |

## NO.4 Package specification

### 4.1 Marking



### 4.2 Label

| KKST KEYUANXIN TECHNOLOGY GO.,LTD |              |                     |
|-----------------------------------|--------------|---------------------|
| Item                              | Crystal      | QTY:<br>3000PCS     |
| P/N                               | KAD27000C01R |                     |
| FREQUENCY                         | 27.000MHz    | DATE:<br>2018-03-12 |
|                                   |              |                     |

### 4.3 Package specification

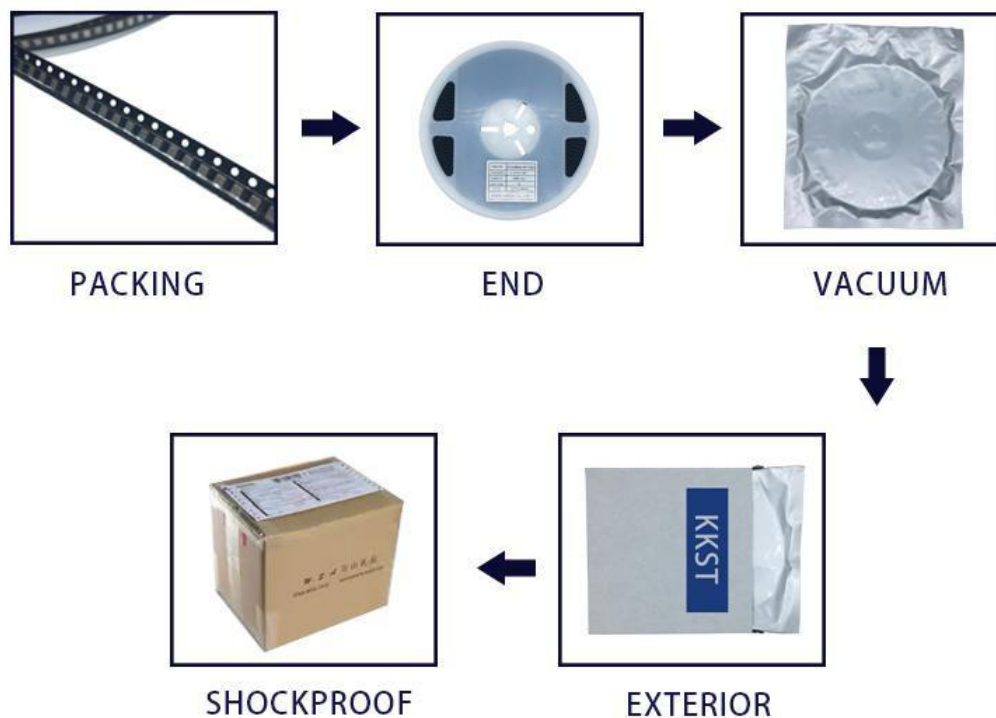



KEYUANXIN TECHNOLOGY GO.,LTD

浏览网址：[www.szkyx.cn](http://www.szkyx.cn)